



Bolt 4K

Zero Delay Wireless
Transmission System

Reference Guide

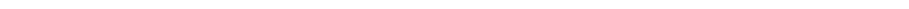
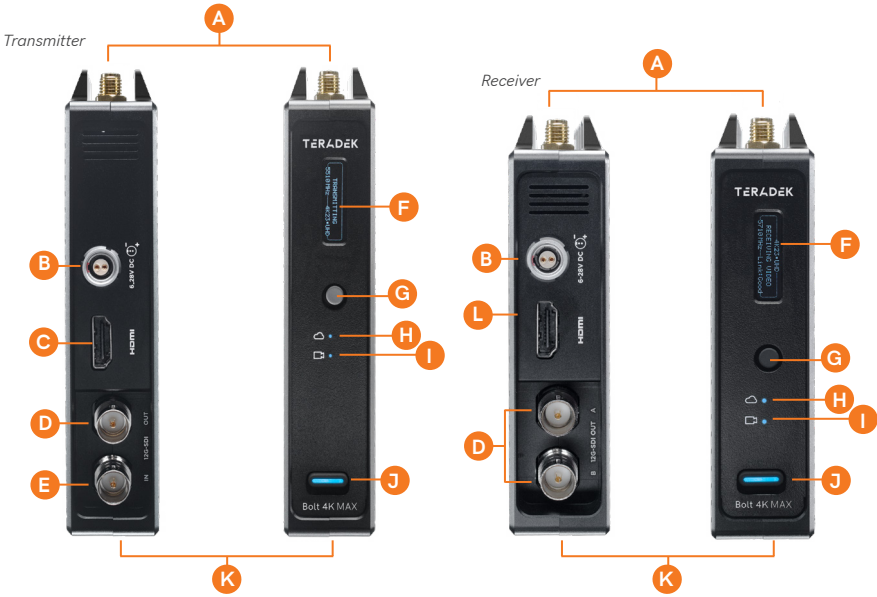

TABLE OF CONTENTS

Physical Properties	2
Getting Started	4
Device Operation	4
Power and Connect	4
Power Connector/Pin-Out	6
Custom 3rd Party Cables	6
12G-SDI Input/Output Cables	6
Pairing	6
Bolt App	8
Mounting	10
Vertical and Horizontal Antennas	10
Recommended Antenna Orientation	10
Bolt Panel Antenna	11
Device Placement	12
Device Settings	13
Transmitter Display Operation	15
Receiver Display/OSD Operation	19
Bolt Manager	25
Troubleshooting/FAQ	27
Frequencies by Region	29
Technical Specifications	30
Regulatory Information	38
Product Information	38
Safety Instructions	38
Warning	38
Antenna	38
A/C Power Adapter	38
Battery	38
RF Modules	39
Unintentional Radio Interference	41
Radio Transmitters	41
EC Declaration of Conformity	43
Waste Electrical and Electronic Equipment	43
Support Resources	43
Disclaimer	43

PHYSICAL PROPERTIES

BOLT 4K



BOLT 4K LT



- A:** RP-SMA connectors
- B:** 6-28V DC power input
- C:** HDMI input
- D:** SDI output
- E:** SDI input
- F:** OLED display
- G:** Menu joystick
- H:** Network status
- I:** Video status
- J:** Power switch
- K:** Micro-USB (not shown)
- L:** HDMI output

BOLT 4K MONITOR MODULE (TX/RX)

Top



- A: RP-SMA connectors
- B: AUX input
- C: 6-18V DC power input
- D: Compression pins
- E: Micro USB
- F: HDMI output
- G: P-Tap output

Bottom



BOLT PANEL ANTENNA V.4

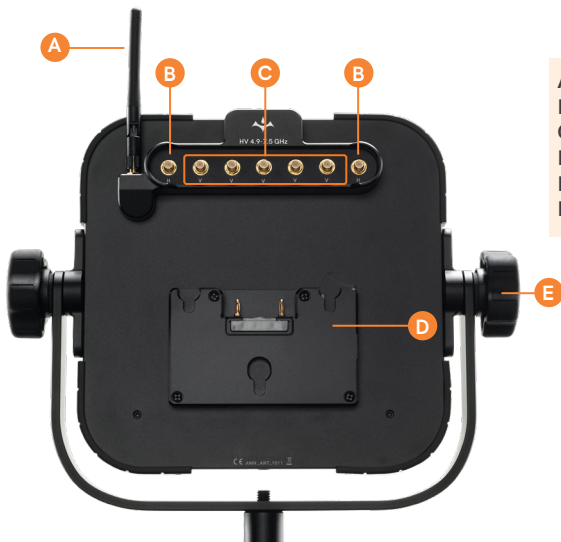

- A: 2dBi Omnidirectional antenna
- B: RP-SMA connectors (horizontal)
- C: RP-SMA connectors (vertical)
- D: Battery plate
- E: Yoke assembly
- F: 3/8" Light stand adapter

OMNIDIRECTIONAL ANTENNA

The included omni-directional antenna (A) can receive a signal from your transmitter even when it's placed behind the Panel Antenna, and supports a wider spectrum (4.9-7.3 GHz).

ANTENNA CONFIGURATION

The Bolt Panel Antenna has both vertical (C) and horizontal (B) antenna connectors. The transmitter's antenna configuration will determine which Panel RP-SMA connectors you use with the receiver. For more information, go to **Vertical and Horizontal Antennas** on pg.10.

GETTING STARTED

DEVICE OPERATION

- For best results when using multiple Bolt systems in the same area, place the transmitters and receivers a few feet apart from each other.
- Operation of other wireless equipment may interfere with the Bolt. Try to separate other wireless transmitters and receivers as much as possible.

POWER AND CONNECT (BOLT 4K/4K LT)

- 1** Connect the output from your video source to either the SDI or HDMI input (**C or E**) on the Bolt transmitter. Connect either the SDI or HDMI output (**D or L**) from the Bolt receiver to the video input on your monitor.

NOTE: If mounting the receiver upright on a stand above the monitor, use a right-angle SDI adapter to relieve any strain caused by the weight of the cable, and to avoid damaging the SDI output's internal connectors.

- 2** Connect power to the Bolt transmitter and receiver with the included A/C adapter, or if both devices are equipped with battery plate accessories, attach a compatible battery (Gold or V mount).
- 3** Attach the antennas to both the transmitter and the receiver.

If using Horizontally Polarized "H" antennas:

- **Bolt 4K transmitters** - Attach two 2dBi antennas to the transmitter's two center connectors and the two "H" antennas to the left and right connectors.
- **Bolt 4K LT transmitters** - Attach one "H" antenna on the connector labeled H (closest to the SDI connectors), and one 2dBi antenna to the opposite connector.
- **Bolt 4K receivers** - Attach the three 2dBi antennas to the receiver's center connectors and the two "H" antennas to the left and right connectors.

If using a Bolt Panel Antenna with the receiver (1500 or MAX only):

Mount the receiver to the back of the antenna, then connect the five RP-SMA connectors to the center connectors labeled **V** using the included extension cables. If the transmitter is using horizontal antennas, attach the receiver's two outward connectors to the antenna's two external connectors labeled **H** (see page 11).

NOTE: Ensure that the 2dBi omnidirectional antenna (**A**) is attached at all times to the Panel Antenna when in use.

- 4** Move the power switches on both the transmitter and receiver (**J**) to the **ON** position. Video appears within a few seconds.

POWER AND CONNECT (BOLT 4K MONITOR MODULE)

- 1 Remove the battery plate from the back of the Smart 7 monitor.
- 2
 - **TX Module** - Detach the cover plate from the back of the Bolt 4K Monitor Module to expose the JST connector.
 - **RX Module** - Remove the battery plate from the back of the Bolt 4K Monitor Module to expose the two top mounting holes.

NOTE: There is no need to disconnect the JST Connector.

- 3 Place the monitor module firmly against the back of the Smart 7 monitor. Ensure the two top mounting holes, connector pins, and micro USB align with their corresponding terminals.

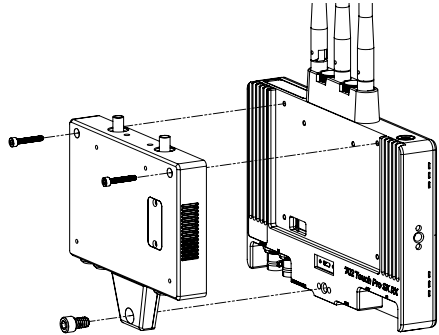

- 4 Insert two M3 socket-head screws through the two top mounting holes on the monitor module and into the back of the monitor (see image). **DO NOT OVER-TIGHTEN.**

- 5
 - **TX Module - (OPTIONAL)** Attach an L-series battery plate to the monitor module, then tighten the four Phillips screws.
 - **RX Module** - Reattach the battery plate to the monitor module, then tighten the four Phillips screws.

NOTE: Before attaching the battery plate to the monitor module, ensure the wires are tucked into the plate so that they do not obstruct the release button's operation.

- 6 Insert, then tighten the 1/4"-20 hex screw to secure the monitor module assembly against the back of the monitor (see image). **DO NOT OVER-TIGHTEN.**
- 7 Attach a compatible battery to the battery plate (**optional for TX Module**), or connect power to the module's 6-18V DC input using the included A/C adapter.

NOTE: Ensure the A/C adapter is connected to the module and NOT the monitor.

- 8 Attach antennas to the monitor module via the threaded RP-SMA connectors, then connect an HDMI cable from the module to the monitor.
- 9 Turn the system on by pressing and holding down the monitor's power button.

POWER CONNECTOR/PIN OUT

Bolt devices use a locking 2-pin power connector similar to the 0B 302 series LEMO connector.

<u>Pin</u>	<u>Description</u>
1*	GND
2	+DC

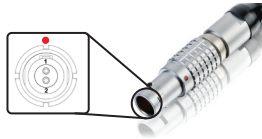

* Pin 1 is closest to the red dot on the connector

CUSTOM/3RD PARTY POWER CABLES

- Test the power cable polarity with **ONLY** the power cable connected to Bolt.
Do not connect video cables.
- Check the power cable for shorts and proper grounding.

CAUTION: Using a reverse polarity or improperly-constructed power cable can damage the product and is not covered under warranty.

12G-SDI CABLES

Bolt 4K devices require the use of 12G-SDI cables in order to reliably transport 12G video signals, and are included as a standard item. Ensure that your cables are rated for compatibility with your camera's output.

PAIRING

Bolt devices purchased as a set (TX and RX), are paired by default, requiring no additional configuration. Bolt devices purchased separately need to be paired using the device's front panel (OLED) menu, **Bolt Manager**, or the **Bolt App**.

NOTE: Before starting either pairing process, ensure that both the transmitter and receiver have the same firmware version and have Bluetooth enabled.

PAIRING VIA THE FRONT PANEL MENU

- 1 Using the Menu Joystick (**G**), navigate to the Pairing menu on both the transmitter and the receiver.
- 2 Select **Pairing** to begin the pairing process. The transmitter will begin scanning for a receiver within range and automatically pair to the receiver.
- 3 Once paired, the front panel will indicate whether or not Pairing is successful.

PAIRING TIPS

If you're having trouble getting units to pair, we recommend keeping the transmitter and receiver six feet apart when pairing (if antennas are connected). Without antennas, they can be closer. Keep all other RF devices nearby turned off or out of range to ensure the transmitter and receiver are only detecting each other. To eliminate any chance of interference, perform the **Wired Pairing** process via Bolt Manager.

PAIRING VIA MONITOR (TX MODULE)

- 1 Swipe right on the monitor's touchscreen until **Monitor Settings** is displayed, then scroll down the left column and navigate to **Accessories>App Connection**, then select **Enable Device Discovery**.
- 2 Scroll back up and tap to select the **TERADEK BOLT 4K** option, then tap **Pair new transmitter (TX)**.
- 3 Enable Pairing on the Bolt 4K receiver by selecting **Pair** on the front panel menu. The TX module will begin scanning for receivers to automatically pair with.
- 4 Once the devices are paired successfully, tap **Accept** to dismiss the menu. If pairing fails, try again.

PAIRING VIA MONITOR (RX MODULE)

- 1 Swipe right on the monitor's touchscreen, then tap on the **Full Settings** option once it appears.
- 2 Tap to select the **TERADEK BOLT 4K** option, then tap **Pair new transmitter (TX)**.
- 3 Enable Pairing on the Bolt 4K receiver by selecting **Pair** on the transmitter's front panel menu. The RX module will begin scanning for the transmitter to automatically pair with.
- 4 Once the devices are paired successfully, tap **Accept** to dismiss the menu. If pairing fails, try again.

WIRED PAIRING VIA BOLT MANAGER

- 1 Connect both the transmitter and receiver(s) to your computer via USB.
- 2 Open Bolt Manager, select the **Pairing** tab, then tap the **Wired Pairing** button.
- 3 Select the devices you want to pair, then click the **Pair Devices** button. Bolt Manager will indicate whether or not Pairing is successful.

PAIRING VIA THE BOLT APP

- 1 Open the Bolt App from your iOS or Android device, then tap the **Pairing** button.
- 2 Select the transmitter you wish to pair, then tap the **Next** button.
- 3 Select the receiver(s) you wish to pair with the transmitter, then tap the **Pair!** button. The Bolt App will indicate when the pairing process is completed.

BOLT APP

Use the Bolt App to remotely manage and monitor every parameter of Bolt 4K including pairing, frequency selection, and 3D LUTs.

CONNECT VIA BLUETOOTH

- 1 Download the Bolt App.
- 2 Enable Bluetooth on your iOS or Android device.
- 3 Navigate to the Bluetooth menu on both the transmitter and receiver, then select **Enable**.
- 4 Open the Bolt App from your iOS or Android device, then tap the **Bolt Devices** button.
- 5 Select the device(s) you want to pair or monitor.



TRANSMITTER STATUS DISPLAY

Settings (Menu descriptions listed on pg. 11) - Tap the  button at the top of the screen to customize the transmitter's various settings.

Spectrum Analyzer - Detects congestion in the area and determines which frequencies are available to use. Each bar represents a frequency, and the height represents the amount of congestion in that frequency; the higher the bar, the more congested that frequency is. Make sure to always select the shortest, least congested bar.

Status - Displays the current status of:

- Video input
- Network
- Connected receivers
- Current frequency
- Quality
- Temperature
- Camera recording
- Region
- Bandwidth
- OSD name

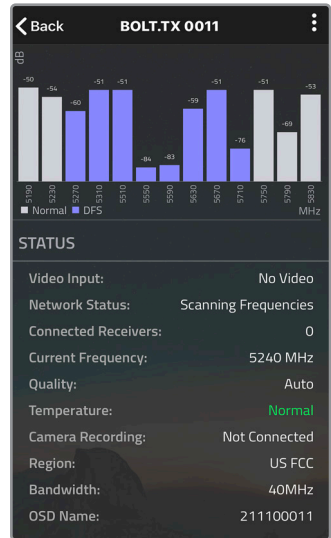

RECEIVER STATUS DISPLAY

Settings (Menu descriptions listed on pg. 11) - Tap the **⋮** button at the top of the display to customize the receiver's various settings such as the output format, audio, display and OSD.

Signal Quality - Determine the quality and reliability of the signal being received.

SNR (Signal to Noise Ratio) - Compare the signal power level to the noise power level from the attached antennas.

Range Analyzer - Displays the transmission distance between the transmitter and receiver.

Spectrum Analyzer - Detects congestion in the area and determines which frequencies are available to use. Each bar represents a frequency, and the height represents the amount of congestion in that frequency; the higher the bar, the more congested that frequency is. Make sure to always select the shortest, least congested bar.

Status - Displays the current status of:

- TX Name
- Network
- Link
- Video input
- Current frequency
- Range
- Quality
- Temperature
- Camera recording
- Bandwidth
- Video output
- OSD name

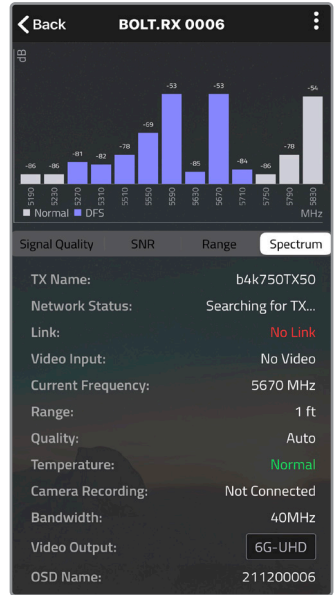

MOUNTING

Bolt 4K transmitters and receivers require the use of external antennas for basic operation. Different conditions will determine the type, orientation, and placement of the antennas.

VERTICAL AND HORIZONTAL ANTENNAS

Vertical (V) antennas are included as a standard item with your Bolt 4K, offering good performance in a wide variety of short-to-medium range situations when quick setup and flexibility is key. V antennas are ideal for achieving diversity indoors. Once you move outdoors with the V antennas, the RF signals travel in a similar or identical manner towards the receiver, weakening diversity. **Horizontal (H) antennas** were designed for use with the V antennas. H antennas cause the RF signal from the transmitter to propagate in a perpendicular manner compared to the vertical signal from the V antenna. The H+V antenna configuration helps to maintain the quality and performance of your video transmission, especially when your signal would otherwise begin to deteriorate due to noise and/or longer ranges.

NOTE: H+V antennas must be attached to both the transmitter and receiver.



Bolt 4K LT system with H+V antennas



Bolt 4K system with H+V antennas

RECOMMENDED ANTENNA ORIENTATION

For most setups, the ideal position for the four TX antennas and the five RX antennas is perpendicular to the ground/horizontal plane so that they point straight up and down. If the transmitter is mounted at an angle or on its side, the antennas must also be arranged so that they point up. Pointing the antennas in any other direction re-ori-ents the radiation pattern and may reduce performance.



Examples of Bolt 4K TX in various mounted positions

BOLT PANEL ANTENNA V.4

If using the **Bolt Panel Antenna V.4** with your Bolt 4K/4K LT 1500 or MAX receiver, you must connect the five RP-SMA connectors from the receiver to the back of the antenna (see below for connector placement), and position the antenna so that the front (with the Teradek logo) has a clear line of sight to the transmitter.



V antenna TX and RX configuration



H+V antenna TX and RX configuration

The Bolt Panel Antenna includes an omnidirectional antenna with a receive pattern that varies based on its distance from the transmitter. The horizontal receive angle measures 55° at 5,000 ft (1.5 km), 104° at 4,000 ft (1.25 km), and is effectively omni-directional at up to 500 ft (150 m). The vertical receive angle measures 20° at any distance. In order to maintain signal strength, you need to adjust the height of the receiver and/or the height of the transmitter accordingly so that there is no more than 20% obstruction. For more information, please visit: <https://support.teradek.com/hc/en-us/articles/4405667258007-Bolt-Panel-Antenna-v4-0-Best-Practices>.

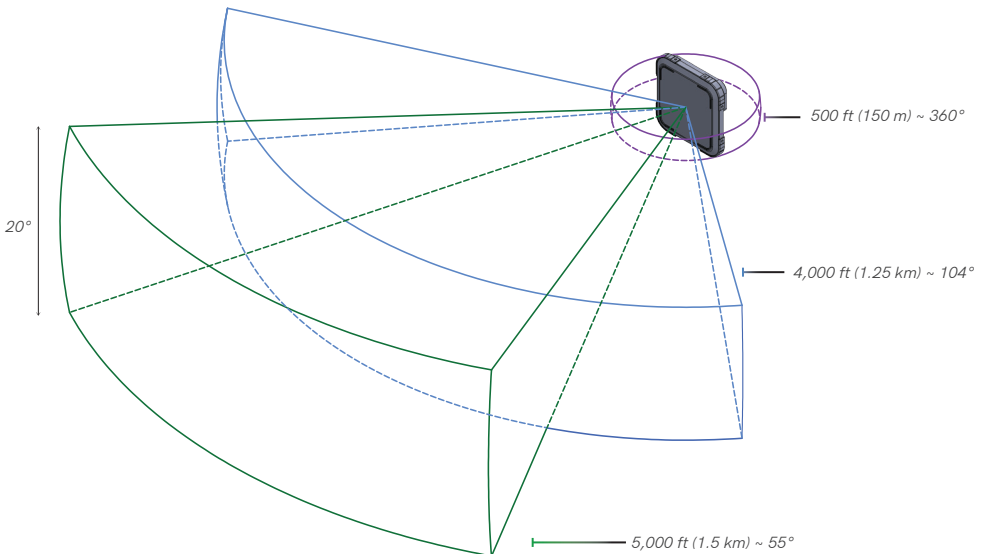

For more information about the different antenna configurations for Bolt 4K, please visit: https://teradek.com/blogs/articles/what-antennas-should-i-use-with-bolt-4k?_pos=1&_sid=cefeb7d2d&_ss=r.

DEVICE PLACEMENT

WITHOUT DUAL MOUNT

Bolt 4K/4K LT devices have a 1/4"-20 threaded hole (additional 3/8"-16 threaded hole on the receiver) on the bottom for mounting the included light stand adapter or any other mounting accessory.

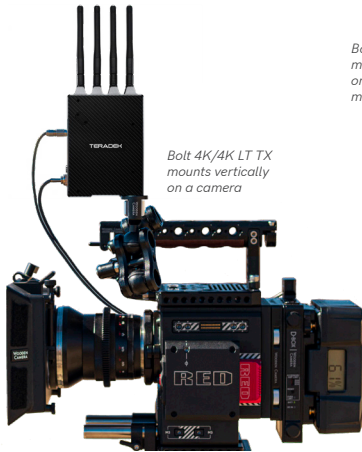

*Bolt 4K/4K LT TX
mounts vertically
on a camera*

*Bolt 4K/4K LT RX
mounts vertically
on a light stand or
monitor*



WITH DUAL MOUNT

Depending on the model, Bolt 4K/4K LT devices are equipped with a dual mount battery plate that allows you to attach your device to either the back of a camera, monitor, or Bolt Panel Antenna.







*Bolt 4K/4K LT TX (w/dual
mount) attaches to the
back of a camera*





*Bolt 4K/4K LT RX (w/dual
mount) mounts on the
back of a monitor or Panel
Antenna*



DEVICE SETTINGS

Bolt 4K and Bolt 4K LT transmitters and receivers share most of the same settings options. Refer to the following settings charts to verify which settings are available on your Bolt 4K unit or set.

						
	BOLT 4K	BOLT 4K MAX	BOLT 4K LT	BOLT 4K LT MAX	TX MODULE	
TRANSMITTER SETTINGS	BROADCAST MODE		●		●	
	FIXED FREQUENCY	●	●	●	●	●
	SELECT BANDWIDTH	●	●	●	●	●
	SELECT FREQUENCY	●	●	●	●	●
	VIDEO QUALITY	●	●	●	●	●
	- Auto Mode	●	●	●	●	●
	- Longer Distance Mode	●	●	●	●	●
	- Better Quality Mode	●	●	●	●	●
	- Best Quality Mode	●	●	●	●	●
	- Low Power Mode	●	●			
	PAIR/UNPAIR	●	●	●	●	●
	BLUETOOTH SETTINGS	●	●	●	●	●
	DISPLAY SETTINGS	●	●	●	●	
	RESET ALL SETTINGS	●	●	●	●	
	DEVICE INFO	●	●	●	●	●
FIRMWARE VERSIONS	●	●	●	●	●	
RENAME RX					●	
FAN MODE	●	●			●	

						
	BOLT 4K	BOLT 4K MAX	BOLT 4K LT	BOLT 4K LT MAX	RX MODULE	
RECEIVER SETTINGS	SWITCH TX	•	•	•	•	•
	FIXED FREQUENCY	•	•	•	•	•
	SELECT BANDWIDTH	•	•	•	•	•
	SELECT FREQUENCY	•	•	•	•	•
	SPECTRUM ANALYZER	•	•	•	•	
	SIGNAL QUALITY GRAPH	•	•	•	•	
	PAIR/UNPAIR	•	•	•	•	•
	HDMI/SDI OUTPUT FORMAT	•	•			
	HDMI SETTINGS	•	•	•	•	
	3D LUT SETTINGS	•	•	•	•	
	TEST PATTERN	•	•	•	•	
	AUDIO SETTINGS	•	•	•	•	
	BLUETOOTH SETTINGS	•	•	•	•	
	VIDEO OSD SETTINGS	•	•	•	•	
	DISPLAY SETTINGS	•	•	•	•	
	RESET ALL SETTINGS	•	•	•	•	
	DEVICE INFO	•	•	•	•	•
	FIRMWARE VERSIONS	•	•	•	•	•
	RENAME TX					•
	FAN MODE	•	•			•

TRANSMITTER DISPLAY OPERATION

Bolt 4K's configuration menus can be accessed from either the transmitter's front panel display or from the Bolt app.

STATUS SCREENS

Press the menu joystick (**G**) to cycle through the status screens or to return from the menu.

- **MAIN STATUS** - Displays the status of the wireless receiver, along with the current video resolution, frequency, and link quality (if connected).
- **INFO** - Displays the current voltage and internal temperature of the unit.
- **HDMI STATUS** - Displays the current HDMI color output.

CONFIGURATION OPTIONS

Most of the options listed in this section can also be configured using the Bolt app. Use the Menu joystick (**G**) to navigate the transmitter's configuration options.

WIRELESS SETTINGS

ENABLE BROADCAST MODE (BOLT 4K MAX/4K-LT MAX ONLY)

Broadcast Mode allows you to transmit to multiple receivers simultaneously (non-DFS frequencies only), while also extending Bolt 4K's transmission range.

- **Broadcast Mode Disabled** (Standard Multicast Mode) - Transmitter and connected receiver(s) coordinate and maintain two-way communication with each other to optimize frequency usage and video transmission.
- **Broadcast Mode Enabled** - Data uplink channel is disabled, allowing the transmitter to connect to an unlimited number of receivers, as long as they have already been paired. To achieve even better range performance, attach the receiver to your **Bolt Panel Antenna** while in Broadcast Mode.

NOTE: Bolt 4K 750 and 1500 receivers will not link to a Bolt 4K MAX transmitter in Broadcast Mode, even if they were previously paired. You must use a Bolt 4K MAX receiver, otherwise the transmitter's OLED will display **Broadcast Not Supported**.

ENABLE FIXED FREQUENCY

Fixed Frequency Mode bypasses any automatic frequency switching logic, allowing your Bolt 4K system to always attempt to connect on a specified frequency. Once a frequency is selected, the transmitter will only use that frequency. This allows your transmitter to link/reconnect to the receiver much faster. After enabling Fixed Frequency mode, navigate to **Frequencies** and select a frequency within the selected wireless region (non-DFS frequencies only). For best results, ensure that both the transmitter and receiver have **Fixed Frequency Mode** enabled, and use the **Spectrum Analyzer** (on the receiver's front panel or the Bolt app) to search for the least congested frequency to use.

- **Fixed Frequency Mode Disabled** - Bolt 4K scans all available channels and repeatedly switches from one frequency to the next during transmission
- **Fixed Frequency Mode Enabled** - Bolt 4K connects to one specific frequency

NOTE: By default, Bolt 4K will select the lowest available frequency from the Frequencies list if one has not been selected beforehand.

SELECT BANDWIDTH

The Bandwidth menu lets you choose between 40MHz (default) and 20MHz operating modes. Ensure that both the transmitter and receiver are set to the same bandwidth with a resolution of up to 1080p60. For all available frequencies, refer to the **FREQUENCIES BY REGION** chart on page 27.

- **20MHz** - Reduces the amount of bandwidth by half, effectively doubling the number of usable frequencies while decreasing interference.
- **40MHz** - (*Default*) Increases the amount of bandwidth by bonding two 20MHz channels, allowing for faster transfer rates but increased interference.

NOTE: 20MHz mode supports HD/3G resolutions up to 1080p60. Resolutions up to 4k30 are also supported, but downscaled to 1080p before transmission (4k50/59/60 is not supported).

SELECT FREQUENCY

The Frequencies menu contains a list of all available frequencies. Bolt 4K will automatically select an operating frequency when multiple values are selected. If both the transmitter and receiver have **Fixed Frequency Mode** enabled, you can only select one frequency for Bolt 4K to use. Frequencies marked with (DFS) must be scanned for one minute before they can be used, but are typically less crowded. For all available frequencies, refer to the **FREQUENCIES BY REGION** chart on page 27.

VIDEO QUALITY

The Video Quality menu lets you adjust the balance between your signal's maximum range and quality according to the number of antennas used to transmit fine information.

- **Auto Mode** - (Default) Transmitter automatically determines how many fine antennas are needed based on the range and signal quality
- **Longer Distance Mode** - (One fine antenna) Maintains the maximum range in situations where other sources of interference might be present, but will slightly reduce your video signal's maximum quality
- **Better Quality Mode** - (Two fine antennas) Maintains higher signal quality, but reduces the maximum range
- **Best Quality Mode** - (Three fine antennas) Ideal for complex, high contrast scenes that require the highest possible quality
- **Low Power Mode** - (One fine antenna with shorter range) Reduces the transmitter's total power consumption by about 1.5W, and may reduce any unwanted interference in multi-system environments

PAIR

Enable pairing on transmitters and receivers. Bolt 4K units purchased as a set (TX and RX) are paired by default, requiring no additional configuration. If the units were purchased separately, or if they have never been paired, you will need to complete the pairing process (page 6). Once **Pairing** is complete, there is no need to repeat the process unless the TX or RX's OSD name has been modified, or if the region has been changed. To confirm if your devices were paired successfully, open either the **Unpair** menu (TX) or the **Switch TX** menu (RX) and verify that the paired device is listed.

NOTE: Before starting the pairing process, ensure that both the transmitter and receiver have the same firmware version and have Bluetooth enabled.

UNPAIR

Unpair and remove devices from your unit's paired device registry. This feature is useful in situations when paired devices are no longer being used and need to either be removed from the registry, or replaced. Transmitters can store up to six paired receivers in its device registry. Pairing more receivers than the maximum six allowed will remove the first paired unit from the device registry.

DISPLAY SETTINGS

Use the Display Settings to control the OLED display operation. By default, the OLED display will invert every 10 minutes. You can set the display to invert every 30 minutes (lengthens the display life), or it can dim or turn off after either 10 minutes or 10 seconds.

- Invert every 30 min
- Dim every 10 min
- Dim after 10 sec
- Invert every 30 min
- Dim every 10 min
- Dim after 10 sec

ADVANCED SETTINGS

LOCK KEYPAD

Enabling the Lock Keypad feature prevents the menu joystick from being used, preventing any accidental or unauthorized configurations. To unlock, press and hold the menu joystick upwards for five seconds or until the display reads "KEYPAD UNLOCKED."

BLUETOOTH

Use the Bluetooth menu to enable or disable Bluetooth communication.

- **Enable Bluetooth** - Allows the transmitter and receiver to be paired and communicate with the Bolt App
- **Use Bluetooth PIN** - Enables the use of a PIN for authentication when using the Bolt App (*see image*)
- **Change PIN** - Press the Menu joystick towards the right to change the Bluetooth PIN

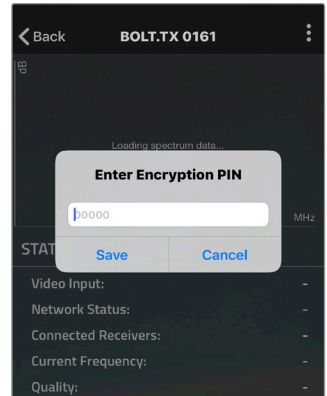

NOTE: Bluetooth is disabled by default. In order to configure your Bolt 4K devices via the Bolt App, you must first enable Bluetooth.

RESET ALL SETTINGS

Reset all configurable options to their factory defaults.

INFO

DEVICE INFO

Displays the model and serial number.

FIRMWARE VERSIONS

Displays the device's current firmware versions.

RECEIVER DISPLAY/OSD OPERATION

Bolt 4K's configuration menus can be accessed from either the receiver's front panel display or from the Bolt app. When enabled, the receiver's configuration menus are also displayed via On-Screen Display (OSD) on a connected monitor.

RECEIVER STATUS SCREENS

Press the menu joystick (**G**) to cycle through the status screens.

- **MAIN STATUS** - Displays the status of the wireless receiver, along with the current video resolution, frequency, and link quality (if connected).
- **TIME CODE** - Displays the current time code if received from the transmitter.
- **INFO** - Displays the current voltage and internal temperature of the unit.
- **TX INFO** - Displays the name of the transmitter it is paired to.
- **HDMI STATUS** - Displays the current HDMI color output.

CONFIGURATION OPTIONS

Most of the options listed in this section can also be configured using the Bolt app. Use the Menu joystick (**G**) to navigate the configuration menus.

SWITCH TX

Bolt 4K receivers can pair with up to four transmitters at a time. **Switch TX** allows you to quickly switch from one paired transmitter's camera feed to another paired transmitter. This feature is especially useful in multi-camera situations when you need to switch to a different camera's view mid-shoot, without having to perform the pairing process every time.

NOTE: The transmitter(s) need to first be paired with the receiver.

WIRELESS SETTINGS

ENABLE FIXED FREQUENCY

Fixed Frequency Mode bypasses any automatic frequency switching logic, allowing your Bolt 4K system to always attempt to connect on a specified frequency. Once a frequency is selected, the transmitter will only use that frequency. This allows your transmitter to link/reconnect to the receiver much faster. After enabling **Fixed Frequency mode**, navigate to **Frequencies** and select a frequency not in use (non-DFS frequencies only). For best results, ensure that both the transmitter and receiver have **Fixed Frequency Mode** enabled, and use the **Spectrum Analyzer** (on the receiver's front panel or the Bolt app) to search for the least congested frequency to use.

- **Fixed Frequency Mode Disabled** - Bolt 4K scans all available channels and repeatedly switches from one frequency to the next during transmission
- **Fixed Frequency Mode Enabled** - Bolt 4K connects to one specific frequency

NOTE: By default, Bolt 4K will select the lowest available frequency from the Frequencies list if one has not been selected beforehand.

SELECT BANDWIDTH

The Bandwidth menu lets you choose between 40MHz (default) and 20MHz operating modes. Ensure that both the transmitter and receiver are set to the same bandwidth with a resolution of up to 1080p60. For all available frequencies, refer to the **FREQUENCIES BY REGION** chart on page 27.

- **20MHz** - Reduces the amount of bandwidth by half, effectively doubling the number of usable frequencies while decreasing interference
- **40MHz** - (*Default*) Increases the amount of bandwidth by bonding two 20MHz channels, allowing for faster transfer rates but increased interference

NOTE: 20MHz mode supports HD/3G resolutions up to 1080p60. Resolutions up to 4k30 are also supported, but downscaled to 1080p before transmission (4k50/59/60 is not supported).

SELECT FREQUENCY

The Frequencies menu contains a list of all available frequencies. Bolt 4K will automatically select an operating frequency when multiple values are selected. If both the transmitter and receiver have **Fixed Frequency Mode** enabled, you can only select one frequency for Bolt 4K to use. Frequencies marked with (DFS) must be scanned for one minute before they can be used, but are typically less crowded. For all available frequencies, refer to the **FREQUENCIES BY REGION** chart on page 27.

TOOLS

SPECTRUM ANALYZER

The built-in Spectrum Analyzer provides a visual indication of channel noise and saturation across the entire available frequency range. Move the Menu joystick left and right to select a frequency, then up and down to enable or disable it.

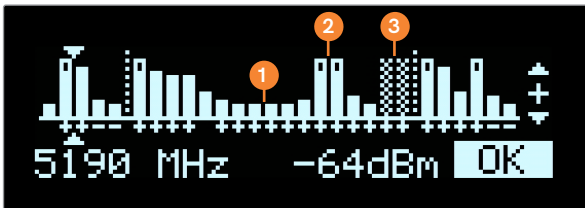

Frequencies are represented by bars; the higher the bar, the more congested that frequency is. Bars without a dot (1) indicate the frequency is not as saturated and can be used. Bars with a dot (2) indicate the frequency is too saturated to connect to. Faded bars (3) represent a frequency that is unavailable for use due to restrictions in particular regions.

SIGNAL QUALITY GRAPH

The Signal Quality Graph indicates the quality and reliability of the signal being received according to the amount of interference that is present between the RX and TX. Signal Quality is represented in percentages:

- Figures below 30% indicate **poor** signal quality
- Figures between 30% and 45% indicate **fair** signal quality
- Figures above 45% indicate **good** signal quality

TEST PATTERN

The Test Pattern menu allows you to select a video resolution format to output a test pattern over HDMI or SDI.

- **Resolutions List** - Select a specific output resolution:
 - 4Kp - 23.98/24/25/29.97/30/50/59.94/60
 - 1080p - 23.98/24/25/29.97/30/50/59.94/60
 - 1080psf - 23.98/24/25/29.97/30
 - 1080i - 50/59.94/60
 - 720p - 50/59.94/60
 - 480p - 59.94/576p - 50 (via HDMI ports only)
 - 480i (NTSC)
 - 576i (PAL)

PAIR

Enable pairing on transmitters and receivers. Bolt 4K units purchased as a set (TX and RX) are paired by default, requiring no additional configuration. If the units were purchased separately, or if they have never been paired, you will need to complete the pairing process (page 6). Once **Pairing** is complete, there is no need to repeat the process unless the TX or RX's OSD name has been modified, or if the region has been changed. To confirm if your devices were paired successfully, open the either the **Unpair** menu (TX) or the **Switch TX** menu (RX) and verify that the paired device is listed.

NOTE: Before starting the pairing process, ensure that both the transmitter and receiver have the same firmware version and have Bluetooth enabled.

UNPAIR

Unpair and remove devices from your unit's paired device registry. This feature is useful in situations when paired devices are no longer being used and need to either be removed from the registry, or replaced. Receivers can store up to four transmitters in its device registry.

HDMI/SDI OUT FORMAT (BOLT 4K ONLY)

You can choose to match the video source's resolution (**Same As Input**), or choose from the resolutions listed. If using the receiver with a recorder or monitor that is sensitive to video signal changes, select **Continuous Output** to ensure the signal stays constant even if the link is interrupted. Keep in mind that selecting Continuous Output adds a small delay to the video output. Selecting **SD**, **HD**, or **6G-UHD** matches the video source's frame rate while adjusting the resolution. This is useful for when you need to down-convert a 4K video to display on an HD monitor.

- **Continuous Output** - Video signal output stays constant when using a monitor or recorder that is sensitive to video signal changes
- **Same As Input** - Matches the transmitter's video source resolution.
- **SD** - Matches the TX frame rate and outputs SD resolution
- **HD** - Matches the TX frame rate and outputs 1920x1080p
- **6K-UHD** - Matches the TX frame rate and outputs 3840x2160
- **Resolutions List** - Select a specific output resolution:
 - 4K (DCI) - 23.98/24/25/29.97/30/50/59.94/60
 - 4K (UHD) - 23.98/24/25/29.97/30/50/59.94/60
 - 1080p - 23.98/24/25/29.97/30/50/59.94/60
 - 1080psf - 23.98/24/25/29.97/30
 - 1080i - 50/59.94/60
 - 720p - 50/59.94/60
 - 480p - 59.94/576p - 50 (via HDMI ports only)
 - 480i (NTSC)
 - 576i (PAL)

3D LUT SETTINGS

The 3D LUT settings menu contains specific looks that can be applied to your video output that either match or simulate how the video will appear after editing, along with options for how they are overlayed on your video output (**Full** or **Split** screen). Additional color preset files can be added and saved from your computer using **Bolt Manager** (page 23).

- **3D LUT Presets** - Select a specific look from the list of 3D LUT presets.
- **3D LUT Mode** - Select whether the look is applied to the entire video output (**Full Screen**) or half (**Split Screen**).

VIDEO OSD SETTINGS

Choose when to display the On-Screen Display (OSD).

- **Never show** - Disable OSD
- **Show when operating** - Hide OSD until it is activated by the joystick.
- **Show when no video** - Display OSD when there is no video feed; hide OSD when video appears (default).
- **Always show** - Always display OSD unless temporarily deactivated by the joystick

DISPLAY SETTINGS

Use the Display Settings to control the OLED display operation. By default, the OLED display will invert every 10 minutes. You can set the display to invert every 30 minutes (lengthens the display life), or it can dim or turn off after either 10 minutes or 10 seconds.

- Invert every 30 min
- Dim every 10 min
- Dim after 10 sec
- Dim after 10 min
- Off after 10 sec
- No BurnIn Prevention

ADVANCED SETTINGS

LOCK KEYPAD

Enabling the Lock Keypad feature prevents the menu joystick from being used, prohibiting any accidental or unauthorized configurations. To unlock, press and hold the menu joystick upwards for five seconds or until the display reads "**KEYPAD UNLOCKED.**"

HDMI SETTINGS

Bolt 4K supports all HDMI output modes. You can select from one of the following options:

- Auto
- RGB 8bit
- RGB 10bit
- YCbCr 4:4:4 8bit
- YCbCr 4:2:2 10bit
- YCbCr 4:2:2 10bit
- YCbCr 4:2:0 8bit
- YCbCr 4:2:0 10bit

AUDIO

Configure Bolt's Audio settings. If **Beep on REC** is activated, you will hear a short tone whenever the camera begins or stops recording. The **Mute Settings** allow you to completely mute audio or only mute audio while recording.

- **Beep on REC** - Short tone when the camera begins or stops recording
- **Mute Settings** - Select an option:
 - Off
 - Mute while record
 - On

BLUETOOTH SETTINGS

Use the Bluetooth menu to enable or disable Bluetooth communication.

- **Enable Bluetooth** - Allows the transmitter and receiver to be paired and communicate with the Bolt App
- **Use Bluetooth PIN** - Enables the use of a PIN for authentication when using the Bolt App (*see image*)
- **Change PIN** - Press the Menu joystick towards the right to change the Bluetooth PIN

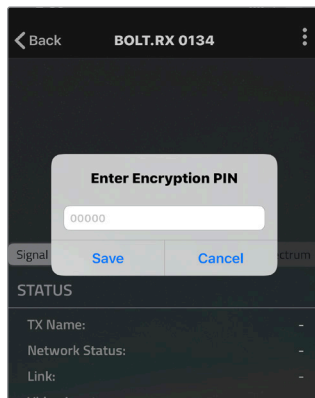

NOTE: Bluetooth is disabled by default. In order to configure your Bolt 4K devices via the Bolt App, you must first enable Bluetooth.

BACKGROUND COLOR

The Background Color feature allows you to select a screen color to be displayed on the monitor when there is no video being received from the transmitter. This is a useful tool that indicates to the crew that a signal has been dropped and the TX and RX need to be synced again.

RESET ALL SETTINGS

Reset all configurable options to their factory defaults.

INFO

DEVICE INFO

Displays the model and serial number.

FIRMWARE VERSIONS

Displays the device's current firmware versions.

BOLT MANAGER

With Bolt Manager, you can configure all of your Bolt 4K devices at once. Available as software for Windows and Mac, Bolt Manager allows you to pair multiple receivers to your transmitter, select frequencies, load 3D LUTs, and perform firmware upgrades.

CONFIGURATION OPTIONS

NOTE: Available configuration settings will differ between Bolt models.

- **Pairing** - Pair or unpair your devices.
- **Settings** - Modify the RX/TX name.
- **Color Processing** - Allows you to apply 3D LUTs to the receiver's video output.
- **Upgrade** - Update your devices with the latest firmware.
- **Status** - Displays detailed information about configuration and update statuses.
- **About** - Displays the software version and License Agreement.

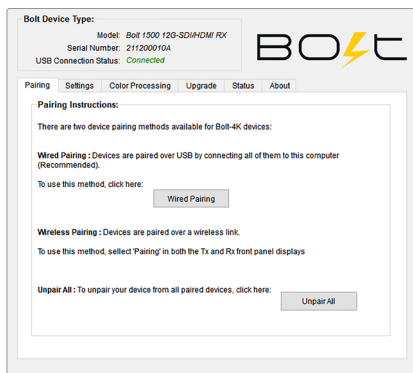

COLOR PROCESSING

Color processing allows users to apply 3D LUTs directly to the receiver's video output or to add, remove, and modify up to 16 LUTs stored in Bolt 4K's memory.

Live LUT - Click **Load** and browse for a 3D LUT file to apply to the video output. The following file formats are supported:

- **.dat** (DaVinci Resolve)
- **.3dl** (Assimilate Scratch)
- **.cube** (DaVinci Resolve)
- **.lut** (Pomfort LiveGrade)
- **.mga** (Final Cut)

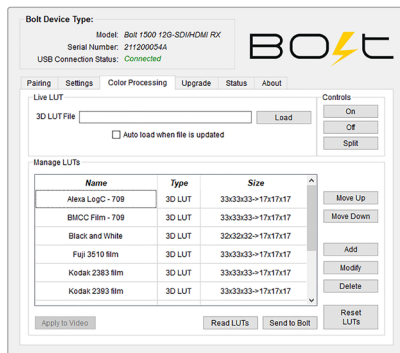

Select **Auto load when file is updated**. The LUT file will be re-read and apply LUT files to the video automatically whenever it is updated on your computer.

Manage LUTs - The LUT manager allows you to select up to 16 3D LUT files to store on Bolt. LUTs can be rearranged, renamed, added, and removed using the corresponding buttons.

- **Sync** - Sync all currently loaded LUTs from the receiver's memory. After syncing, the LUTs will be displayed in the manager window.
- **Apply to Video** - Apply the selected 3D LUT file to the video output. Once applied, the LUT file can be turned **On**, **Off**, or applied to half the display using the **Split** option.
- **Read LUTs** - Read Bolt's storage and overwrite the contents of the LUT management window.
- **Send to Bolt** - Load your LUT presets to your device.
- **Reset LUTs** - Reset Bolt's storage to default values. A number of pre-defined LUTs are contained in the default configuration.

UPGRADE

Teradek releases firmware updates periodically that add new features, improve performance, and fix vulnerabilities. To update Bolt 4K, you'll need to load a firmware package into Bolt Manager.

Load from Web - If you have an Internet connection, click **Load from Web** to download the latest firmware package from Teradek's servers.

Load from PC - Click **Load from PC** if you have already downloaded the firmware package you wish to use. For latest firmware, visit: <https://www.teradek.com/pages/downloads#bolt4k>

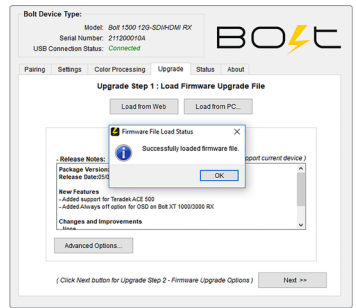

Once the firmware is loaded, and information about the package is displayed, click **Next** to proceed with the upgrade. You will then be presented with a list of device components and whether or not they are scheduled to be updated, along with two options:

Start Upgrade - Update your Bolt 4K device(s) with the latest firmware version.

Advanced Options - View version details for each component and the firmware upgrade package components. The Advanced screen also allows users to select which components to upgrade.

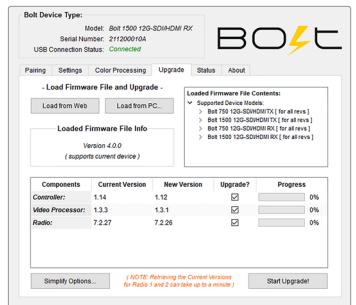

TROUBLESHOOTING/FAQ

CAN I DOWN-CONVERT FROM 4K TO HD IN ORDER TO DISPLAY VIDEO ON AN HD MONITOR?

Yes. Even if you feed the transmitter a 4K signal, you can output an HD signal from a paired receiver. Output settings are configured on the receiver (see page **20**) or the Bolt app.

WILL BOLT 4K WORK WITH MY CURRENT BOLT?

No. Previous generation Bolts cannot communicate with Bolt 4K. Bolt 4K uses a different RF system along with a unique chipset not found in any of the previous generation Bolts.

DOES BOLT 4K SUPPORT SDI METADATA/ANCILLARY DATA PASSTHROUGH?

Bolt 4K supports a limited subset of SDI ancillary data (metadata) from certain cameras. The following data can be passed wirelessly from the transmitter to the receiver:

- Start/stop record flags
- Time code
- File/clip name (RED, ARRI, and Sony cameras)
- Full metadata except for LUTs (ARRI cameras)

The following cameras are capable of transmitting SDI ancillary data, although any camera with time code embedded in the SDI signal should work:

- **RED Epic, Scarlet** - Supports time code, record start/stop, and file/clip name
- **ARRI** - Supports full metadata (except for LUTs)
- **Canon C300/C500/XF305/XF105** - Supports time code and record start/stop
- **Sony VENICE F3/F5/F55** - Supports time code and record start/stop
- **Panasonic** - Supports time code

THE BOLT APP DOES NOT DISPLAY MY BOLT 4K UNIT.

Ensure that both your Bolt 4K and cellular device have Bluetooth enabled (see page 6). By default, Bluetooth is disabled on your Bolt 4K device until you enable it.

CAN I USE ANY SDI OR HDMI CABLE WITH MY BOLT 4K UNITS?

No. You should make sure that your SDI or HDMI cable is capable of handling **6G** or **12G** video. If using HDMI cables, it is recommended that you use an HDMI 2.0 compatible cable, and regularly check if your cables are still functional. HDMI cables are extremely delicate and repeated bending can damage the internal wiring to the point where it will no longer send a signal (especially a 4K signal).

HOW MANY RECEIVERS CAN I LINK TO ONE BOLT 4K TRANSMITTER?

You can link up to six Bolt 4K/Bolt 4K LT receivers to any one Bolt 4K/Bolt 4K LT transmitter. On Bolt 4K MAX/Bolt 4K LT MAX transmitters with **Broadcast Mode** enabled (see page **13**), you can link to an unlimited number of Bolt 4K MAX/Bolt 4K LT MAX receivers.

WHAT ARE THE A/C POWER REQUIREMENTS FOR BOLT 4K?

Bolt 4K devices require more power than any of our previous products. When powering Bolt 4K from an A/C outlet, use only the included A/C adapter. This A/C adapter has a higher voltage capacity that meets Bolt 4K's increased power requirements. Lower rated A/C adapters are not supported, and using one will affect Bolt 4K's performance and capabilities.

NOTE: These requirements only apply if you are using an A/C outlet to power on Bolt 4K. Using a compatible battery and accessory cable as a power source will not affect Bolt 4K's performance.

Supported A/C adapters:

- 9V 2.0A (18W)
- 12V 1.5A (18W)
- 12V 3.0A (included with Bolt 4K)
- 12V 2.5A (30W)
- 24V 2.5A (60W)

Not supported:

- 12V 1.25A (15W)

CAN I INSTALL BATTERY PLATES ON MY BOLT 4K UNITS MYSELF?

Yes. Recent changes to the device's chassis allows the user to assemble and install battery plates on either the receiver or transmitter. Earlier Bolt 4k units required battery plates to be installed only by a trained technician at a Certified Teradek Repair Center. Contact Teradek to verify if your device's metal work is the latest.

FREQUENCIES BY REGION

NOTE: Pairing the TX and RX is required after a different region is selected.

Bandwidth (MHz)	Freq Range		US (FCC)		EU		Canada		Japan		Australia/New Zealand	
	40	20	40	20	40	20	40	20	40	20	40	20
UNII1 (Non DFS)		5160		5160		5160						5160
	5190	5180	5190	5180	5190	5180	5190	5180	5190	5180	5190	5180
		5200		5200		5200		5200		5200		5200
	5230	5220	5230	5220	5230	5220	5230	5220	5230	5220	5230	5220
		5240		5240		5240		5240		5240		5240
	UNII2 (DFS)	5270	5260	5270	5260	5270	5260	5270	5260	5270	5260	5270
5280			5280		5280		5280		5280		5280	
5310		5300	5310	5300	5310	5300	5310	5300	5310	5300	5310	5300
		5320		5320		5320		5320		5320		5320
		5340				5340						5340
5510		5500	5510	5500	5510	5500	5510	5500	5510	5500	5510	5500
		5520		5520		5520		5520		5520		5520
5550		5540	5550	5540	5550	5540	5550	5540	5550	5540	5550	5540
		5560		5560		5560		5560		5560		5560
5590		5580	5590	5580	5590	5580	5590	5580	5590	5580	5590	5580
		5600		5600		5600		5600		5600		5600
5630		5620	5630	5620	5630	5620	5630	5620	5630	5620	5630	5620
		5640		5640		5640		5640		5640		5640
5670/ 5690/ 5710		5660	5670	5660	5690	5660	5690	5660	5670	5660	5670	5660
		5680		5680		5680		5680		5680		5680
		5700	5710	5700	5710	5700	5710	5700	5710	5700	5710	5700
	5720	5720		5720		5720		5720		5720		
UNII3 (Non DFS)	5755	5745	5750	5740	5750	5755	5745	5755	5745	5755	5745	
		5765		5760			5765		5765			
	5795	5785	5790	5780	5790	5795	5785	5795	5785	5795	5785	
		5805		5800			5805		5805			
		5825	5830	5820	5830	5830	5825	5830	5825	5830	5825	
				5840			5840		5840		5840	

TECHNICAL SPECIFICATIONS

BOLT 4K SYSTEM

	BOLT 4K TX	BOLT 4K RX
VIDEO		
Video Inputs	12G-SDI SMPTE 2082-1 standard/75 Ω, 1x HDMI 2.0 Type-A receptacle	N/A
Video Outputs	1x Loopout 12G-SDI SMPTE 2082-1 standard/75 Ω	2x 12G-SDI SMPTE 2082-1 standard/75 Ω, 1x HDMI 2.0 Type-A receptacle
SDI Ancillary Data Support	Supports transmitting metadata, timecode, and start/stop flags from certain camera manufacturers.	
Color Sampling	SDI: YCbCr 4:2:2 10-Bit/HDMI: RGB 4:4:4, 8-bit	SDI: YCbCr 4:2:2 10-Bit/HDMI: RGB 4:4:4, 8-bit
Delay (TX to RX)	<0.001sec (without format conversions)	<0.001sec (without format conversions)
Supported Resolutions	4Kp23.98/24/25/29.97/30/50/59.94/60 1080p23.98/24/25/29.97/30/50/59.94/60 1080psf23.98/24/25/29.97/30 1080i50/59.94/60 720p50/59.94/60 480p59.94/576p50 (via HDMI ports only) 480i (NTSC)/576i (PAL)	4Kp23.98/24/25/29.97/30/50/59.94/60 1080p 23.98/24/25/29.97/30/50/59.94/60 1080psf23.98/24/25/29.97/30 1080i50/59.94/60 720p50/59.94/60 480p59.94/576p50 (via HDMI ports only) 480i (NTSC)/576i (PAL)
Input Cross Conversion	Yes, HDMI to SDI	N/A
Output Video Scaling	N/A	Yes, Framerate and Resolution Scaling
VIDEO PROCESSING		
Video Compression	Visually lossless	N/A
Test Pattern Generator	N/A	Yes
Video Format Conversion Support	Yes	Yes
Spectrum Analyzer	N/A	Yes
Color Correction	N/A	17x17x17 3D LUT
AUDIO		
Audio Compression	48kHz 24-bit PCM	48kHz 24-bit PCM
Audio Input	Embedded SDI/HDMI Audio Input (2 channel)	N/A
Audio Output	N/A	Embedded SDI/HDMI Audio Input (2 channel)

BOLT 4K TX

BOLT 4K RX

PHYSICAL ATTRIBUTES

Dimensions	5.2" x 3.6" x 1.1" (132 x 91 x 27mm)	4.4" x 5.5" x 1.1" (112 x 139 x 27mm)
Weight	12.7oz (360g)	15.3oz (434g)
Construction	Milled aluminum (chassis), regulation-compliant PCB	Milled aluminum (chassis), regulation-compliant PCB

INTERFACES

Configuration Interface	OLED Screen with Menu Joystick Navigation	OLED Screen with Menu Joystick Navigation
Switches	On/Off Switch	On/Off Switch
Desktop App	Bolt Manager app (OSX and Windows)	Bolt Manager app (OSX and Windows)
Mobile App	Bolt App (iOS and Android)	Bolt App (iOS and Android)
USB Interface	Upgrade via Micro-USB	Upgrade via Micro-USB
Bluetooth Compatibility	Bolt App	Bolt App

NETWORK

Wireless	DFS Frequencies: 5.270 ~ 5.670 GHz Non-DFS Frequencies: 5.190 ~ 5.230 GHz and 5.755 ~ 5.795 GHz	DFS Frequencies: 5.270 ~ 5.670 GHz Non-DFS Frequencies: 5.190 ~ 5.230 GHz and 5.755 ~ 5.795 GHz
Bluetooth	2.4 GHz	2.4 GHz
RF Channel Selection	Auto, Manual	Auto, Manual
Encryption	AES-256, RSA-1024 key exchange	AES-256, RSA-1024 key exchange
RF power	21 dbm EIRP (max power)	18 dbm EIRP (max power)
Antennas	MAX: 2x External 2dBi antennas, 2x H-V antennas 750/1500: 4x External 2dBi antennas	MAX: 3x External 2dBi antennas, 2x H-V antennas 750/1500: 5x External 2dBi antennas
Range	MAX: Up to 3000ft (914m) line of sight (5000ft [1524m] with optional Panel Antenna) 1500: Up to 1500ft (457m) line of sight 750: Up to 750ft (229m) line of sight	
Multicast	750/1500: Connect one transmitter to up to 6 receivers MAX (with Broadcast Mode enabled): Connect one transmitter to unlimited receivers	
Noise Rejection	Can coexist with Wi-Fi and 5GHz cordless phones, Can operate up to 6 sets in same location	Can coexist with Wi-Fi and 5GHz cordless phones, Can operate up to 6 sets in same location

BOLT 4K SYSTEM (cont.)

	BOLT 4K TX	BOLT 4K RX
POWER		
Power Input	2-Pin Circular locking connector 6-28 VDC	2-Pin Circular locking connector 6-28 VDC
Nominal Power Consumption	19 Watts	15 Watts
Operating Temperature	32~104°F (0~40°C)	32~104°F (0~40°C)
GENERAL		
Mountability	MAX: Integrated Gold or V Battery Mount, Multiple mounting options with M3, 3/8" and 1/4-20" holes 750/1500: Multiple mounting options with M3, 3/8" and 1/4-20" holes	MAX: Integrated Gold or V Battery Mount, Multiple mounting options with M3, 3/8" and 1/4-20" holes 750/1500: Multiple mounting options with M3, 3/8" and 1/4-20" holes

BOLT PANEL ANTENNA V.4

WIRELESS	
Frequency Range	4.9 - 7.5 GHz
Gain	14 and 16dBi
Polarization	2x Horizontal and 5x Vertical for polarization.
Beam-width deg horizontal	75°
Beam-width deg vertical	35°
Impedance	50 ohm
PHYSICAL ATTRIBUTES	
Dimensions	13.78 x 13.78 x 1.25 in (35 x 35 x 3.18 cm)
Weight	39oz [1111.3g]
Construction	UV-protected plastic with aluminum alloy (construction grade)
Connectors	RP-SMA
Operating temperature	-40~176°F (-40°C to 80°C)

BOLT 4K LT SYSTEM

	BOLT 4K LT - TX	BOLT 4K LT - RX
VIDEO		
Video Inputs	3G-SDI SMPTE 424M standard/75 Ω (BNC x 1), 1x HDMI 1.4b Type-A receptacle	N/A
Video Outputs	3G-SDI SMPTE 424M standard/75 Ω (BNC x 1)	3G-SDI SMPTE 424M standard/75 Ω (BNC x 1), 1x HDMI 1.4b Type-A receptacle
SDI Ancillary Data Support	Supports transmitting metadata, timecode, and start/stop flags from most camera manufacturers. Please refer to: https://support.teradek.com/hc/en-us/articles/217446087	
Color Sampling	SDI: YCbCr 4:2:2, 10-Bit/HDMI: RGB 4:4:4, 8-bit	SDI: YCbCr 4:2:2, 10-Bit/HDMI: RGB 4:4:4, 8-bit
Delay (TX to RX)	<0.001sec (without format conversions)	<0.001sec (without format conversions)
Supported Resolutions	4Kp23.98/24/25/29.97/30 (HDMI only) 1080p23.98/24/25/29.97/30/50/59.94/60 1080psf23.98/24/25/29.97/30 1080i50/59.94/60 720p50/59.94/60 480p50 576p59.94/60 480i(NTSC)/576i(PAL)	4Kp23.98/24/25/29.97/30 (HDMI only) 1080p23.98/24/25/29.97/30/50/59.94/60 1080psf23.98/24/25/29.97/30 1080i50/59.94/60 720p50/59.94/60 480p50 576p59.94/60 480i(NTSC)/576i(PAL)
Input Cross Conversion	Yes, HDMI to SDI	N/A
Output Video Scaling	N/A	No
VIDEO PROCESSING		
Video Compression	Visually lossless	N/A
Test Pattern Generator	N/A	Yes
Spectrum Analyzer	N/A	Yes
AUDIO		
Audio Compression	48kHz 24-bit PCM	48kHz 24-bit PCM
Audio Input	Embedded SDI/HDMI Audio Input (2 channel)	N/A
Audio Output	N/A	Embedded SDI/HDMI Audio Input (2 channel)

BOLT 4K LT SYSTEM (cont.)

BOLT 4K LT - TX

BOLT 4K LT - RX

INTERFACES

Configuration Interface	OSD with Menu, Joystick Navigation	OSD Screen with Menu, Joystick Navigation
Switches	On/Off Switch	On/Off Switch
Desktop App	Bolt Manager application for OSX & Windows	Bolt Manager application for OSX & Windows
Mobile App	Bolt App	Bolt App
USB Interface	Upgrade via Micro-USB	Upgrade via Micro-USB
Bluetooth Compatibility	Yes	Yes

NETWORK

Wireless	DFS Frequencies: 5.270 ~ 5.670 GHz Non-DFS Frequencies: 5.190 ~ 5.230 GHz and 5.755 ~ 5.795 GHz	DFS Frequencies: 5.270 ~ 5.670 GHz Non-DFS Frequencies: 5.190 ~ 5.230 GHz and 5.755 ~ 5.795 GHz
Bluetooth	2.4 GHz	2.4 GHz
RF Channel Selection	Auto, Manual	Auto, Manual
Encryption	AES-256, RSA-1024 key exchange	AES-256, RSA-1024 key exchange
RF power	19 dbm EIRP (2x external 2dBi antennas; <80mW transmit power)	17 dbm EIRP (1x external 2dBi antenna; <51mW transmit power)
Antennas	2x External 2dBi antennas (included)	5x External 2dBi antennas (included)
Range	MAX: Up to 3000ft (914m) line of sight (5000ft [1524m] with optional Array Antenna) 1500: Up to 1500ft (457m) line of sight 750: Up to 750ft (229m) line of sight	
Multicast	750/1500: Connect one transmitter to up to 6 receivers MAX (with Broadcast Mode enabled): Connect one transmitter to unlimited receivers	
Noise Rejection	Can coexist with Wi-Fi and 5GHz cordless phones, and can operate up to 6 sets in same location	Can coexist with Wi-Fi and 5GHz cordless phones, and can operate up to 6 sets in same location
Interoperability	Can transmit wireless video to all ranges of Bolt 4K XT and Bolt 4K LT receivers (limited by shortest range device)	Can receive wireless video from all ranges of Bolt 4K XT and Bolt 4K LT transmitters (limited by shortest range device)

BOLT 4K LT - TX**BOLT 4K LT - RX****PHYSICAL ATTRIBUTES**

Dimensions	2.4" x 4.1" x 1.3" (60 x 103 x 33mm)	4.8" x 3.7" x 1" (122 x 94 x 27mm)
Weight	7.3oz (206g)	10.3oz (292g)
Construction	Milled aluminum (chassis) and regulation-compliant PCB	Milled aluminum (chassis) and regulation-compliant PCB

POWER

Power Input	2-Pin Circular locking connector 6-28 VDC	2-Pin Circular locking connector 6-28 VDC
Battery	None, optional Sony/Canon dual battery plate	None, optional Gold or V mount battery plate
Nominal Power Consumption	9 Watts	11 Watts
Operating Temperature	32~104°F (0~40°C)	32~104°F (0~40°C)

GENERAL

Mountability	Multiple mounting options with M3 and 1/4-20" holes	Multiple mounting options with 3/8"x16 and 1/4-20" holes
--------------	---	--

BOLT 4K MONITOR MODULE (TX/RX)

VIDEO

Video Input/ Output 1x HDMI 2.0 Type-A receptacle, feeds into Smart 7 HDMI input via block connector

Color Sampling **HDMI:** RGB 4:4:4, 8-bit

Delay (TX to RX) <0.001sec (without format conversions)

Supported Resolutions 4Kp23.98/24/25/29.97/30 (4K signals will be displayed as 1080p on monitor)
1080p23.98/24/25/29.97/30/50/59.94/60
1080psf23.98/24/25/29.97/30
1080i50/59.94/60
720p50/59.94/60
480p50
576p59.94/60
480i(NTSC)/576i(PAL)

Output Video Scaling No

VIDEO PROCESSING

Video Compression Visually lossless

Color Correction Via Smart7 Monitor (**RX module only**)

AUDIO PROCESSING

Audio Compression 48kHz 24-bit PCM

Audio Output Embedded HDMI Audio Output (2 Channel) into monitor, out on headphones

PHYSICAL ATTRIBUTES

Dimensions 5" x 4.6" x 1" (128 x 118 x 19mm)

Weight **Without battery plate:** 16.6oz (470g)
With battery plate: 18.6oz (526g)

Construction Milled aluminum (chassis) and regulation-compliant PCB

INTERFACES

Configuration Interface OSD on monitor, Bolt App

Switches N/A

Mobile App Bolt App

USB Interface Functionality Upgrade via Micro-USB

NETWORK

Wireless **DFS Frequencies:**
5.270 ~ 5.670 GHz
Non-DFS Frequencies:
5.190 ~ 5.230 GHz and 5.755 ~ 5.795 GHz

RF Channel Selection Auto, Manual

Encryption AES-256, RSA-1024 key exchange

RF power 17 dbm EIRP (1x external 2dBi antenna; <51mW transmit power)

Antennas **RX Module:** 5x External 2dBi antennas (included)
TX Module: 2x External 2dBi antennas (included)

Range **1500:** Up to 1500ft (457m) line of sight
750: Up to 750ft (229m) line of sight

Multicast Can connect one transmitter to up to 6 receivers

Noise Rejection Can coexist with Wi-Fi and 5GHz cordless phones, and can operate up to 6 sets in same location

POWER

Power Input 2-Pin Circular locking connector 6-28 VDC

Battery Gold or V mount battery plate

Nominal Power Consumption 10 Watts

Operating Temperature 32~104°F (0~40°C)

GENERAL

Mountability Mounts in between SmallHD Smart 7 monitor and battery plate.

REGULATORY INFORMATION

PRODUCT INFORMATION

This product is designed to be compliant with rules and regulations in the country it is sold to and therefore is marked as required. These markings signify the countries the device is approved in. Operating the product without regulatory approval is illegal. Any changes or modifications to the product not expressly approved by Teradek could void the user's authority to operate the equipment and its regulatory approvals. Please make sure you use the latest revision of this document which is available at teradek.com.

SAFETY INSTRUCTIONS

- Keep these instructions in a safe and accessible place for future use.
- When operating this equipment, read and follow all the instructions in this manual.
- Do not open the unit.
- Do not block the air ventilation openings, and provide proper ventilation for the units to allow it to cool down during operation.
- Use only accessories/batteries/chargers specified or recommended by Teradek.
- When devices are switched ON, keep away at least 20 cm (7.9 in) from your body.
- People with pacemakers should **ALWAYS** keep the device at the listed distance from their pacemaker when turned ON. Should you have any reason to suspect that interference is taking place, you should turn your device OFF.
- Do not expose to moisture, excessive heat or fire.
- Keep away from water and other liquids.
- Clean with a dry cloth only.
- Unplug this apparatus during lightning storms or when unused for long periods of time.
- To reduce the risk of fire or electric shock, refer servicing to qualified service personnel.
- Declared maximum operating temperature: +40°C
- Please avoid electrostatic discharge from the antenna ports for proper operation

WARNING

Bolt 4K devices contain sensitive electronic components that can be damaged by electrostatic discharge (ESD). When handling, care must be taken so that the device is not damaged. Damage due to inappropriate handling is not covered by the warranty. For complete warranty information, please see the warranty card that arrived with the device, or visit www.teradek.com/pages/warranty-information.

ANTENNA

The product is provided with an approved antenna. Use only supplied or approved antennas by Teradek. Any changes or modifications to the antenna may void the regulatory approvals obtained for the product.

USING THE AC POWER ADAPTER

- All components must be dry before connecting to an external power source
- Use **ONLY** a UL/IEC 62368 or UL/IEC 60950-1 2nd revision approved AC/DC power adapter class LPS with electrical output ratings range of 6-28 V DC, 3A, with ambient temperature range of 0°C to 40°C.
- Use of an alternative AC/DC power adapter will invalidate any approvals given to this unit and may be dangerous.

BATTERY

This device is not supplied with batteries. In case a battery is used, please adhere to the following general battery usage guidelines:

- Use batteries with the rated voltage and current characteristics as listed in the manual.
- Use IEC 62133 approved lithium batteries such as the **Anton Bauer Digital Battery (Dionix XT 150/Dionix XT 90)**.
- Verify battery temperature is within the range specified.
- Do not use incompatible/incorrect batteries. Use of an incompatible battery may present a risk of fire, explosion, leakage, or other hazard.
- Severe impact from dropping any battery-operated device on a hard surface could cause the battery to overheat.

RF MODULES

These devices contain the following approved radio modules:

DEVICE	DESCRIPTION	IC	FCC ID
AMN41012	HD Video Transmitter	7680A-AMN41012	VQSAMN41012
AMN42012	HD Video Receiver	7680A-AMN42012	VQSAMN42012
2832	BT Module	4492A-2832	HSW2832

RF EXPOSURE

The product complies with internationally recognized standards covering human exposure to electromagnetic fields from radio devices. To satisfy local RF exposure regulation requirements, the transmitting product must operate with a minimum separation distance of 20 cm or more from a person's body.

FCC RF EXPOSURE STATEMENT

This equipment complies with the FCC RF radiation exposure limits set forth for an uncontrolled environment. This equipment should be installed and operated with a minimum distance of 20 centimeters between the radiator and your body. This transmitter must not be co-located or operating in conjunction with any other antenna or transmitter.

IC RADIATION EXPOSURE STATEMENT

Important Note: Radiation Exposure Statement

This equipment complies with IC radiation exposure limits set forth for an uncontrolled environment. This equipment should be installed and operated with minimum distance 20cm between the radiator and your body.

Note Importante: Déclaration d'exposition aux radiations

Cet équipement est conforme aux limites d'exposition aux rayonnements IC établies pour un environnement non contrôlé. Cet équipement doit être installé et utilisé avec un minimum de 20 cm de distance entre la source de rayonnement et votre corps.

Antenna Information

The radio transmitters **7680A-AMN41012 (HD Transmitter)**, **7680A-AMN42012 (HD Receiver)**, and **4492A-2832 (BT Module)** have been approved by Industry Canada to operate with the antenna types listed below with the maximum permissible gain indicated. Antenna types not included in this list, having a gain greater than the maximum gain indicated for that type, are strictly prohibited for use with this device. Under Industry Canada regulations, this radio transmitter may only operate using an antenna of a type and maximum (or lesser) gain approved for the transmitter by Industry Canada. To reduce potential radio interference to other users, the antenna type and its gain should be so chosen that the equivalent isotropically radiated power (e.i.r.p.) is not more than that necessary for successful communication.

Informations sur l'antenne

Les présent émetteur radios **7680A-AMN41012 (HD Transmitter)**, **7680A-AMN42012 (HD Receiver)**, and **4492A-2832 (BT Module)** ont été approuvé par Industrie Canada pour fonctionner avec les types d'antenne énumérés ci-dessous et ayant un gain admissible maximal et l'impédance requise pour chaque type d'antenne. Les types d'antenne non inclus dans cette liste, ou dont le gain est supérieur au gain maximal indiqué, sont strictement interdits pour l'exploitation de l'émetteur. Conformément à la réglementation d'Industrie Canada, le présent émetteur radio peut fonctionner avec une antenne d'un type et d'un gain maximal (ou inférieur) approuvé pour l'émetteur par Industrie Canada. Dans le but de réduire les risques de brouillage radioélectrique à l'intention des autres utilisateurs, il faut choisir le type d'antenne et son gain de sorte que la puissance isotrope rayonnée équivalente (p.i.r.e.) ne dépasse pas l'intensité nécessaire à l'établissement d'une communication satisfaisante.

MODULES IC	ANTENNA	MAX. PERMISSIBLE GAIN	LOCATION	ANTENNA IMPEDANCE
7680A-AMN41012	Dipole	2dBi Typical at 5GHz	External	50Ω
7680A-AMN41012	Dipole	5dBi Typical at 5GHz	External	50Ω
7680A-AMN42012	Dipole	2dBi Typical at 5GHz	External	50Ω
7680A-AMN42012	Printed	11dBi typical at 5GHz	External	50Ω
4492A-2832	Internal antenna		Internal	

UNINTENTIONAL RADIO INTERFERENCE

FCC COMPLIANCE STATEMENT

This equipment has been tested and found to comply with the limits for a Class A digital device, pursuant to Part 15 of the FCC rules. These limits are designed to provide reasonable protection against harmful interference in a residential installation. This equipment generates, uses, and can radiate radio frequency energy, and, if not installed and used in accordance with the instructions, may cause harmful interference to radio communications. However, there is no guarantee that interference will not occur in a particular installation. If this equipment does cause harmful interference to radio or television reception, which can be determined by turning the equipment off and on, the user is encouraged to try to correct the interference by one or more of the following measures:

- Reorient or relocate the receiving antenna.
- Increase the separation between the equipment and the receiver.
- Connect the equipment into an outlet on a circuit different from that to which the receiver is connected.
- Consult the dealer or an experienced radio or television technician for help

This equipment complies with **Part 15** of the FCC rules. Operation is subject to the following two conditions:

1. This device may not cause harmful interference, and
2. This device must accept any interference received, including interference that may cause undesired operation.

IC COMPLIANCE STATEMENT - CAN ICES-3 (A)/NMB-3 (A)

This device complies with the Innovation, Science and Economic Development Canada's licence-exempt RSS(s). Operation is subject to the following two conditions:

1. This device may not cause harmful interference, and
2. This device must accept any interference received, including interference that may cause undesired operation.

L'émetteur/récepteur exempt de licence contenu dans le présent appareil est conforme aux CNR d'Innovation, Sciences et Développement économique Canada applicables aux appareils radio exempts de licence. L'exploitation est autorisée aux deux conditions suivantes:

1. L'appareil ne doit pas produire de brouillage, et
2. L'appareil doit accepter tout brouillage radioélectrique subi, même si le brouillage est susceptible d'en compromettre le fonctionnement.

RADIO TRANSMITTERS

FCC STATEMENT

Radio Transmitters (Part 15) – Class A Digital Devices

This device complies with Part 15 of the FCC Rules. Operation is subject to the following two conditions:

1. This device may not cause harmful interference, and
2. This device must accept any interference received, including interference that may cause undesired operation.

IC STATEMENT

This device complies with RSS-247 of the Industry Canada Rules. Operation is subject to the following two conditions:

1. This device may not cause harmful interference, and
2. This device must accept any interference received, including interference that may cause undesired operation.

Ce dispositif est conforme à la norme CNR-247 d'Industrie Canada applicable aux appareils radio exempts de licence. Son fonctionnement est sujet aux deux conditions suivantes:

1. Le dispositif ne doit pas produire de brouillage préjudiciable, et
2. Ce dispositif doit accepter tout brouillage reçu, y compris un brouillage susceptible de provoquer un fonctionnement indésirable.

IC STATEMENT - OPERATION AT 5GHZ RANGE

Caution:

1. The device for operation in the band 5150-5250 MHz is only for indoor use to reduce the potential for harmful interference to co-channel mobile satellite systems;
2. Users should also be advised that high-power radars are allocated as primary users (i.e. priority users) of the bands 5250-5350 MHz and 5650-5850 MHz and that these radars could cause interference and/or damage to LE-LAN devices.
3. The maximum antenna gain permitted for devices in the bands 5250-5350 MHz and 5470-5725 MHz shall be such that the equipment still complies with the e.i.r.p. limit;
4. The maximum antenna gain permitted for devices in the band 5725-5850 MHz shall be such that the equipment still complies with the e.i.r.p. limits specified for point-to-point and non point-to-point operation as appropriate.

Avvertissement:

1. Les dispositifs fonctionnant dans la bande 5 150-5 250 MHz sont réservés uniquement pour une utilisation à l'intérieur afin de réduire les risques de brouillage préjudiciable aux systèmes de satellites mobiles utilisant les mêmes canaux;
2. De plus, les utilisateurs devraient aussi être avisés que les utilisateurs de radars de haute puissance sont désignés utilisateurs principaux (c.-à-d., qu'ils ont la priorité) pour les bandes 5 250-5 350 MHz et 5 650-5 850 MHz et que ces radars pourraient causer du brouillage et/ou des dommages aux dispositifs LAN-EL.
3. Le gain d'antenne maximum autorisé pour les appareils fonctionnant sous les bandes de fréquences 5250-5350 MHz et 5470-5725 MHz doit être tel que l'équipement est toujours conforme à la limite PIRE;
4. Le gain d'antenne maximum autorisé pour les appareils fonctionnant sous les bandes de fréquences 5725-5850 MHz doit être tel que l'équipement est toujours conforme à la limite PIRE spécifiée pour un fonctionnement point à point et non point à point, le cas échéant.

EC DECLARATION OF CONFORMITY

This equipment may be operated in all EU countries with the following restrictions:

- 5.15-5.35GHz frequencies for indoor use only



Teradek hereby declares that this Radio Transmitter is in compliance with the essential requirements and other relevant provisions of Directives 2014/53/EU and 2011/65/EU. The full text of the EU DoC is located at: <https://support.teradek.com/hc/en-us/articles/233429747-EC-Declaration-of-Conformity-for-CE-mark>



WASTE ELECTRICAL AND ELECTRONIC EQUIPMENT (WEEE)

English: Waste electrical and electronic equipment should not be disposed of with household waste. Please recycle where facilities exist. Check with your local authority or retailer for recycling advice.

Français: Déchets d'équipements électriques et électroniques ne doit pas être jeté avec les ordures ménagères. S'il vous plaît recycler où les installations existent. consultez auprès de votre autorité locale ou le détaillant pour obtenir des conseils de recyclage.

Deutsch: Elektro- und Elektronik-Altgeräte dürfen nicht mit dem Hausmüll entsorgt werden. Bitte recyceln, wo Anlage vorhanden sind. Beraten Sie sich bei Ihrer lokale Behörde oder Händler über Recycling information.

SUPPORT RESOURCES

In addition to this Reference Guide, you can find more information on Bolt 4K devices' features and operation by visiting www.teradek.com. If you are unable to find what you need online, please contact Teradek's support staff.

E-mail: support@teradek.com | Phone: (888) 941-2111 ext. 2 (available M-F 7am-6pm PST)

DISCLAIMER

This manual is intended for user information only. Every effort has been made to ensure that the contents within are accurate at the time of printing, and that updates are made in a timely manner. Teradek cannot be held responsible for inaccuracies, typographical errors, or out-of-date information contained within this manual.